

e.04

edarredo.

“Il contenuto viene prima del design.
Il design, senza contenuti,
non è design, è decorazione”.

Jeffrey Zeldman

edarredo.

e.04

Aria nuova.
/ *New air.*



Essenziale. Moderna. Funzionale.
/ *Essential. Modern. Functional.*

L'importanza dei materiali
/ *The importance of materials*

L'igiene nello studio ha la massima priorità. I nostri prodotti vengono realizzati in acciaio al carbonio, materiale inorganico, impermeabile, non poroso, riducendo la proliferazione di patogeni. Eventuali residui liquidi vengono eliminati con le normali operazioni di pulizia. Nella costante ricerca di miglioramento, selezioniamo materiali tecnici quali FENIX®, CORIAN®, vetro per rispondere alle esigenze di funzionalità, design e sostenibilità.



/ *Hygiene in the practice has the highest priority. Our products are made of carbon steel, an inorganic, waterproof and non-porous material, reducing the proliferation of pathogens. Liquid residues are eliminated with normal cleaning operations. Continuously looking for improvement, we select technical materials such as FENIX®, CORIAN® and glass to meet the needs of functionality, design and sustainability.*

e.04 / comp.01

Lo studio non è mai stato così bello.
Una collezione interamente pensata sotto
l'aspetto ergonomico e funzionale.

Le molteplici configurazioni di modularità,
colori, materiali, rendono la collezione e.04
il modello ideale per dare spazio alle tue idee,
per arredare gli ambienti professionali
in modo esclusivo e distintivo.

*/ The studio has never looked so good.
A collection entirely designed to assure
ergonomics and functionality.*

*The multiple configurations, colors, materials,
make the e.04 the right collection to give space
to your ideas, to make professional environments
exclusive and distinctive.*







e.04 / comp.02

Pensata per il professionista che vuole creare un ambiente dinamico e fuori dagli schemi. Ogni dettaglio della collezione e.04 è stato pensato per ottimizzare l'operatività quotidiana.

/ Designed for the professional who wants to create a dynamic, out-of-the-box studio. Every detail of the e.04 collection has been designed to optimize efficiency on a daily basis.



e.04 / comp.03

A fianco il colore Blu Genziana, il Bianco Traffico e piani di lavoro in Corian sono il perfetto abbinamento per questo ambiente dal tocco raffinato.

/ Alongside the color Blu Genziana, Bianco Traffico and Corian worktops are the perfect combination for this space with an elegant touch.







Package.01 /

Caratteristiche / Details

Dimensioni / Dimensions

2000 x 500 x 850 h.

Basi / Bases

4 moduli L.500 - 1 servomobile L.500
4 modules L.500 - 1 servomobile L.500

Colori / Colors

Frontali, cassetti e scocca Bianco Traffico RAL 9010
Fronts, drawers and structure Bianco Traffico RAL 9010

Maniglie / Handles

ED1614 Silver

Piano / Top

Laminato postforming bianco
White postforming laminate

Lavello / Sink

ALAVI01 / ALAVV01

Miscelatore / Tap

AMIX_8003

*con ALAVI08 / with ALAVI08

EURO 190,00 + IVA

Prezzi / Prices

Comp.01 su zoccolo / on base

EURO 5.029,00 + IVA

Comp.01 su piedino / on foot

EURO 5.170,00 + IVA

Imballo / Pack

EURO 170,00 + IVA





Package.02 /

Caratteristiche / Details

Dimensioni / Dimensions

1500 x 500 x 850 h.

Basi / Bases

3 moduli L.500 - 1 servomobile L.500
3 modules L.500 - 1 servomobile L.500

Colori / Colors

Frontali, cassetti e scocca Bianco Traffico RAL 9010
Fronts, drawers and structure Bianco Traffico RAL 9010

Maniglie / Handles

ED1614 Silver

Piano / Top

Laminato postforming bianco
White postforming laminate

Lavello / Sink

ALAVI01 / ALAVV01

Miscelatore / Tap

AMIX_8003

*con ALAVI08 / with ALAVI08

EURO 190,00 + IVA

Prezzi / Prices

Comp.02 su zoccolo / on base

EURO 4.076,00 + IVA

Comp.02 su piedino / on foot

EURO 4.229,00 + IVA

Imballo / Pack

EURO 130,00 + IVA





Package.03 /

Caratteristiche / Details

Dimensioni / Dimensions

2100 x 500 x 850 h.

Basi / Bases

3 moduli L.500 - 1 servomobile L.500
3 modules L.500 - 1 servomobile L.500

Colori / Colors

Frontali, cassetti e scocca Bianco Traffico RAL 9010
Fronts, drawers and structure Bianco Traffico RAL 9010

Maniglie / Handles

ED1614 Silver

Piano / Top

Laminato postforming bianco
White postforming laminate

Lavello / Sink

ALAVI01 / ALAVV01

Miscelatore / Tap

AMIX_8003

*con ALAVI08 / with ALAVI08

EURO 190,00 + IVA

Prezzi / Prices

Comp.03 su zoccolo / on base

EURO 4.144,00 + IVA

Comp.03 su piedino / on foot

EURO 4.297,00 + IVA

Imballo / Pack

EURO 130,00 + IVA





Package.04 /

Caratteristiche / Details

Dimensioni / Dimensions

2100 x 500 x 850 h.

Basi / Bases

3 moduli L.500 - 1 servomobile L.500
3 modules L.500 - 1 servomobile L.500

Colori / Colors

Frontali, cassetti e scocca Bianco Traffico RAL 9010
Fronts, drawers and structure Bianco Traffico RAL 9010

Maniglie / Handles

ED1614 Silver

Piano / Top

Laminato postforming bianco
White postforming laminate

Lavello / Sink

ALAVI01 / ALAVV01

Miscelatore / Tap

AMIX_8003

*con ALAVI08 / with ALAVI08

EURO **190,00** + IVA

Prezzi / Prices

Comp.04 su zoccolo / on base

EURO **3.954,00** + IVA

Comp.04 su piedino / on foot

EURO **4.107,00** + IVA

Imballo / Pack

EURO **130,00** + IVA

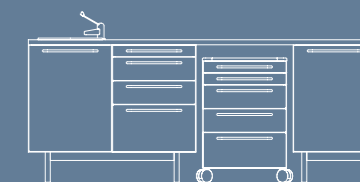
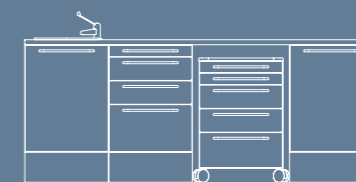

e.04 / Dettagli tecnici / *Technical details*

Colori / Colours

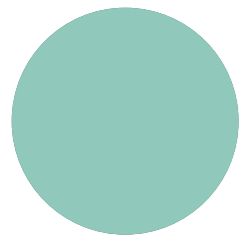

Verde Polinesia

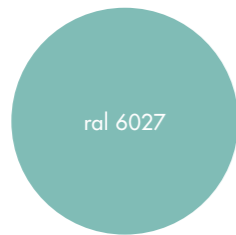

Verde Menta

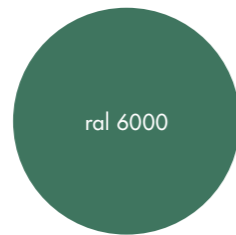

Verde Patina

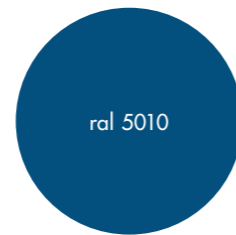

Blu Genziana

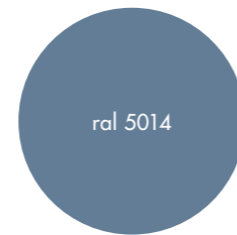

Blu Colomba

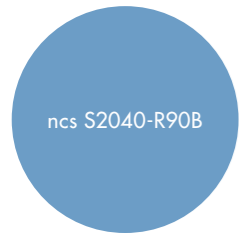

Azzurro

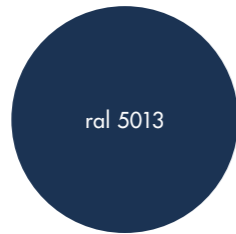

Blu Cobalto

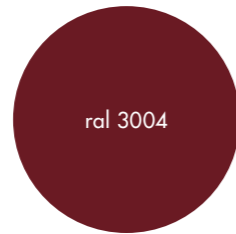

Rosso Porpora

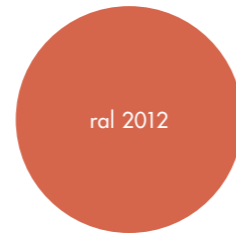

Arancio Salmone

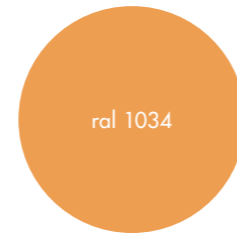

Giallo Pastello

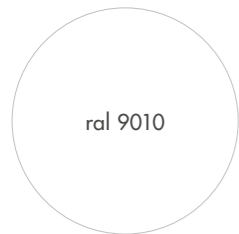

Bianco Traffico

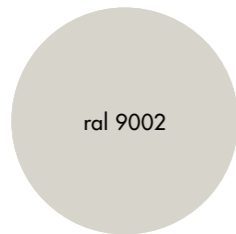

Bianco Grigio

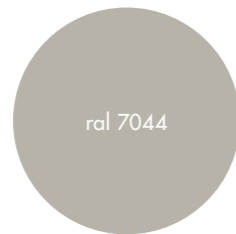

Grigio Seta

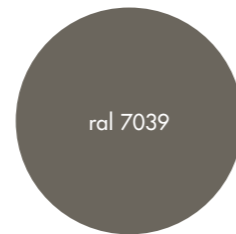

Grigio Quarzo

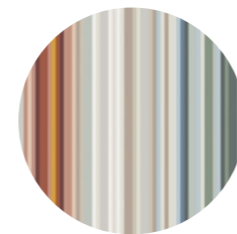

RAL o NCS su richiesta
RAL or NCS upon request

Maniglie / Handles



ED1614
soft close



ED2997
soft close

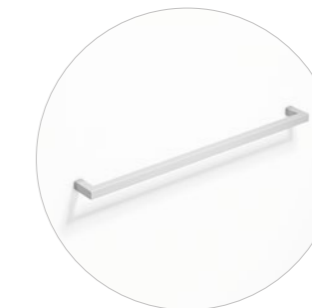

ED3006
soft close



ED1252
soft close

Miscelatori / Tap



AMIX8003
miscelatore / mixer



AMIX8007
miscelatore / mixer



AMIX0006
miscelatore / mixer



M03
miscelatore / mixer

e.04 / Vasca / Sink

INOX Vasca / INOX Sink



ALAVI01
inox - sopra top
/ inox drop in sink



ALAVI07
inox - sotto top
/ inox undermount sink



ALAVI08
inox - sopra top
/ inox drop in sink



Inox

CERAMICA Vasca / CERAMIC Sink



ALAVV01
ceramica - filo top
/ ceramic flush mounted sink

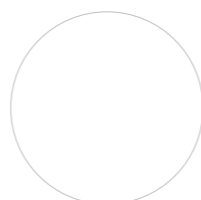

Ceramica
/ Ceramic

Vasca integrata / Integrated sink

CORIAN® Vasca integrata / CORIAN® integrated sink



ALAVC07
corian - termoformato
/ thermoformed corian



ALAVC10
corian - termoformato
/ thermoformed corian

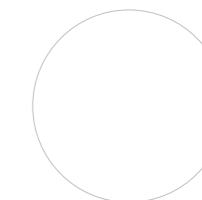

Glacier White

VETRO Vasca integrata / GLASS integrated sink



ALAVG01
vetro - termoformato
/ thermoformed glass

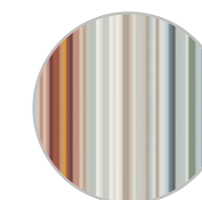

Tutti i colori della collezione e.04
+ RAL o NCS su richiesta
/ All e.04 collection colors + RAL or NCS upon request

e.04 / Top / Top

FENIX® top 20mm / FENIX® top 20mm

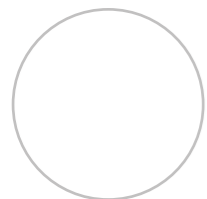

Bianco Kos

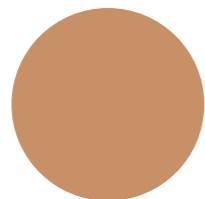

Giallo Evora

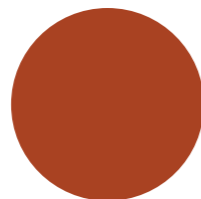

Rosso Namib

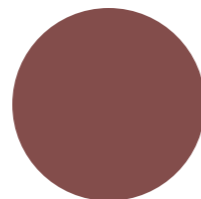

Rosso Askja



Verde Kitami

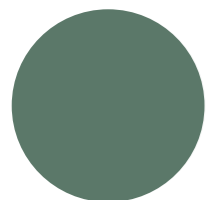

Verde Brac

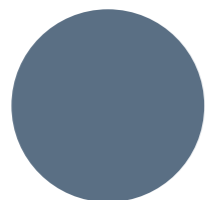

Azzurro Naxos

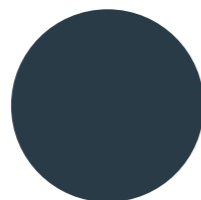

Blu Shaba

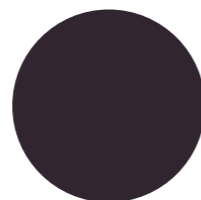

Viola Orissa

CORIAN® top 12mm / CORIAN® top 12mm

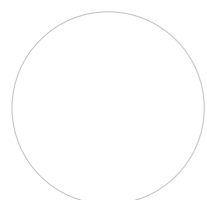

Glacier White

Vetro top 15mm / Glass top 15mm

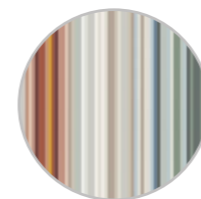

Tutti i colori della collezione e.04 + RAL o NCS su richiesta
/ All e.04 collection colors + RAL or NCS upon request

HPL top 12mm / HPL top 12mm



Bianco / White

Laminato top 30mm / Laminate top 30mm



Bianco / White

e.04 / Interno cassetto / *Drawer's interior*

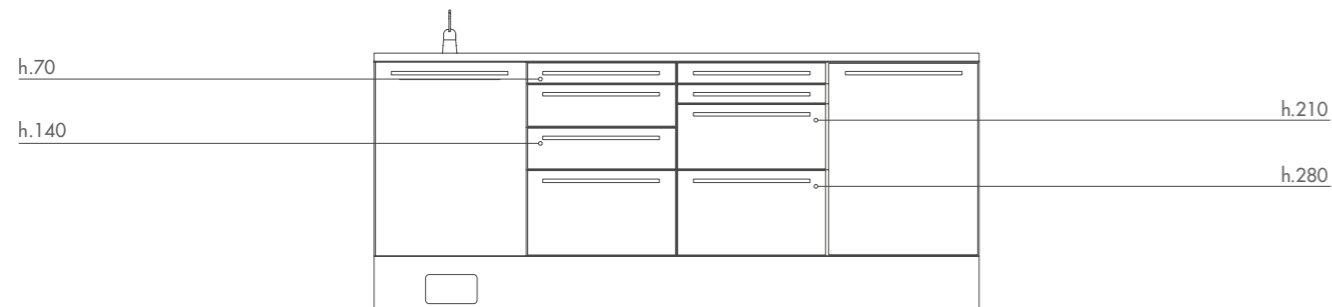

cassetto h.70 / *drawer h.70*



AGVAS001



AGVAS002



AGVAS003



AGVAS004



AGVAS005



AGVAS006

cassetto h.140 / *drawer h.140*



AGVAS011



AGVAS012



AGVAS013



AGVAS014

cassetto h.210/280 / *drawer h.210/280*



AGVAS021

from e.04

to e.Steril

e.Steril

La sterilizzazione è il cuore pulsante dello studio, molte volte defilata e in spazi che non le rendono giustizia.

Noi abbiamo pensato di farla diventare un ambiente bello e funzionale allo stesso tempo. La collezione e.steril è pensata per essere "messa in vetrina".

/ Sterilization is the beating heart of the studio, many times defiladed and in tight spaces.

We want to make it beautiful and functional at the same time. The e.steril collection is designed to be "showcased."







e.Steril /

Dettagli tecnici / *Technical details*

Colori / *Colours*

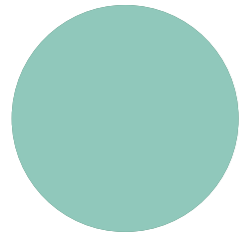

Verde Polinesia

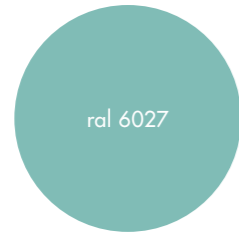

Verde Menta

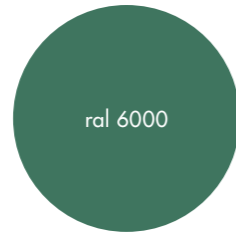

Verde Patina

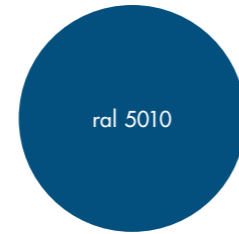

Blu Genziana

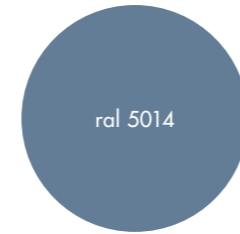

Blu Colomba

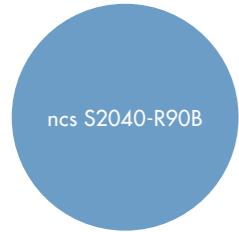

Azzurro

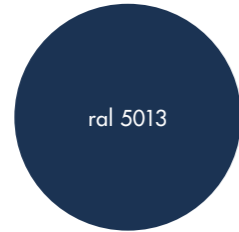

Blu Cobalto

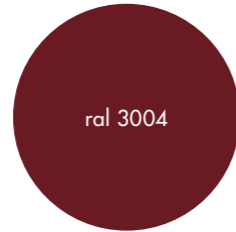

Rosso Porpora

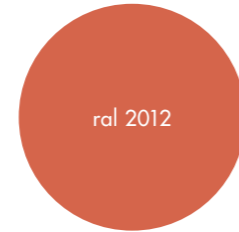

Arancio Salmone

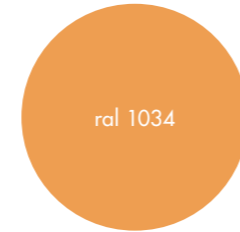

Giallo Pastello

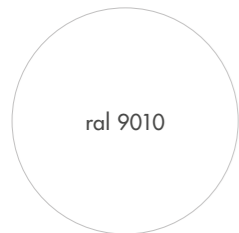

Bianco Traffico

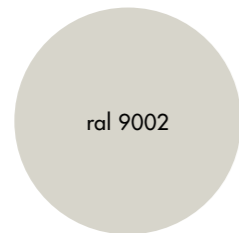

Bianco Grigio

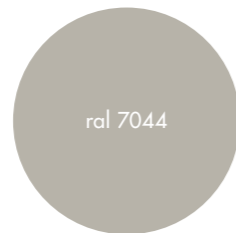

Grigio Seta

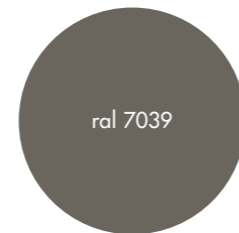

Grigio Quarzo

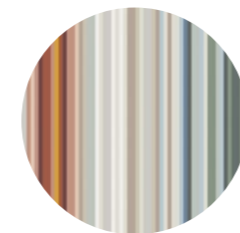

RAL o NCS su richiesta
RAL or NCS upon request

Maniglie / *Handles*



ED1614
soft close



ED2997
soft close

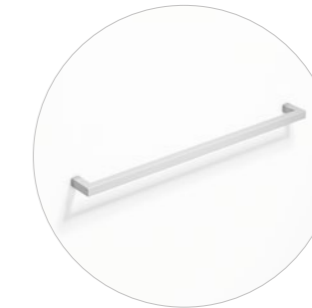

ED3006
soft close



ED1252
soft close

Miscelatori / *Tap*



AMIX8007
miscelatore / mixer



AMIX0037
miscelatore / mixer

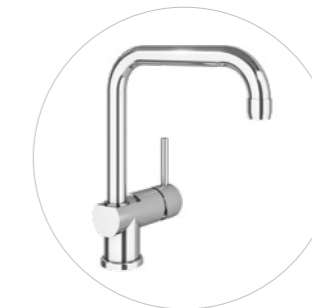

BIBO
miscelatore / mixer



BIBO-DE
miscelatore / mixer

e.Steril / Top e Vasche / Top and Sinks

CORIAN® top / CORIAN® top

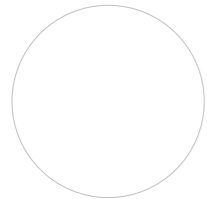

Glacier White

HPL top / HPL top

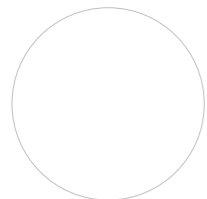

Bianco / White

Laminato top / Laminate top

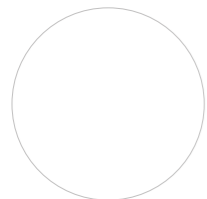

Bianco / White

INOX top / INOX top



Inox

INOX Vasca / INOX Sink



ALAVI02
Inox - sotto top
/ inox undermount sink



ALAVI03
Inox - sopra top
/ inox drop in sink



ALAVI04
Inox - sgocciolatoio DX
/ inox drainer to the right



ALAVI05
Inox - sgocciolatoio SX
/ inox drainer to the left



ALAVI06
Inox - doppia vasca
/ inox double bowl sink



ALAVI07
Inox - sotto top
/ inox undermount sink



ALAVI08
Inox - sopra top
/ inox drop in sink



Inox

e.Steril / Complementi in Inox / *Inox complements*

I nostri prodotti, realizzati interamente in inox, sono il giusto completamento di sterilizzazioni e sale operatorie, donando luce al tuo ambiente.

/ Our products, made entirely of stainless steel, are the right complement to sterilisations and operating theatres, bringing light to your environment.

Lavamani / *Hands basin*



Codice / Code
AGENI005

Dimensioni / Dimensions
480 x 360 x 520 h.

Prezzo / Price EURO **1.197,00** + IVA

Portarifiuti / *Waste basket*



Codice / Code
AGENI001

Dimensioni / Dimensions
Ø 380 x 610 h.

Prezzo / Price EURO **571,00** + IVA

Lavabraccia Chirurgico / *Surgical washbasin*



Codice / Code
AGENI008

Dimensioni / Dimensions
600 x 430 x 1185 h.

Prezzo / Price EURO **3.311,00** + IVA

Carrello multifunzione / *Trolley*



Codice / Code
AGENI003

Dimensioni / Dimensions
600 x 500 x 925 h.

Prezzo / Price EURO **702,00** + IVA

Codice / Code
AGENI004

Dimensioni / Dimensions
800 x 500 x 925 h.

Prezzo / Price EURO **747,00** + IVA

Progetto Ambiente

Progetto Ambiente

Profondo know-how del prodotto ed un gusto riconoscibile, questa la forte distinzione che caratterizza ogni progetto; una narrazione varia, perché "convenzionale", in edarredo, non esiste. Ci occupiamo direttamente della progettazione e della realizzazione di spazi professionali, operativi e di completamento, quali: studio, laboratorio, sala corsi, uffici, sale d'attesa, reception, spazi comuni e dedicati al personale della clinica.

/ Deep product know-how and a recognizable taste, this is the strong distinction that characterizes each project; a varied narrative, because "conventional," in edarredo, does not exist. We handle the design and realization of clinic's professional, operational and complement spaces, such as: studio, laboratory, training room, offices, waiting rooms, reception, common and dedicated spaces for clinic staff.

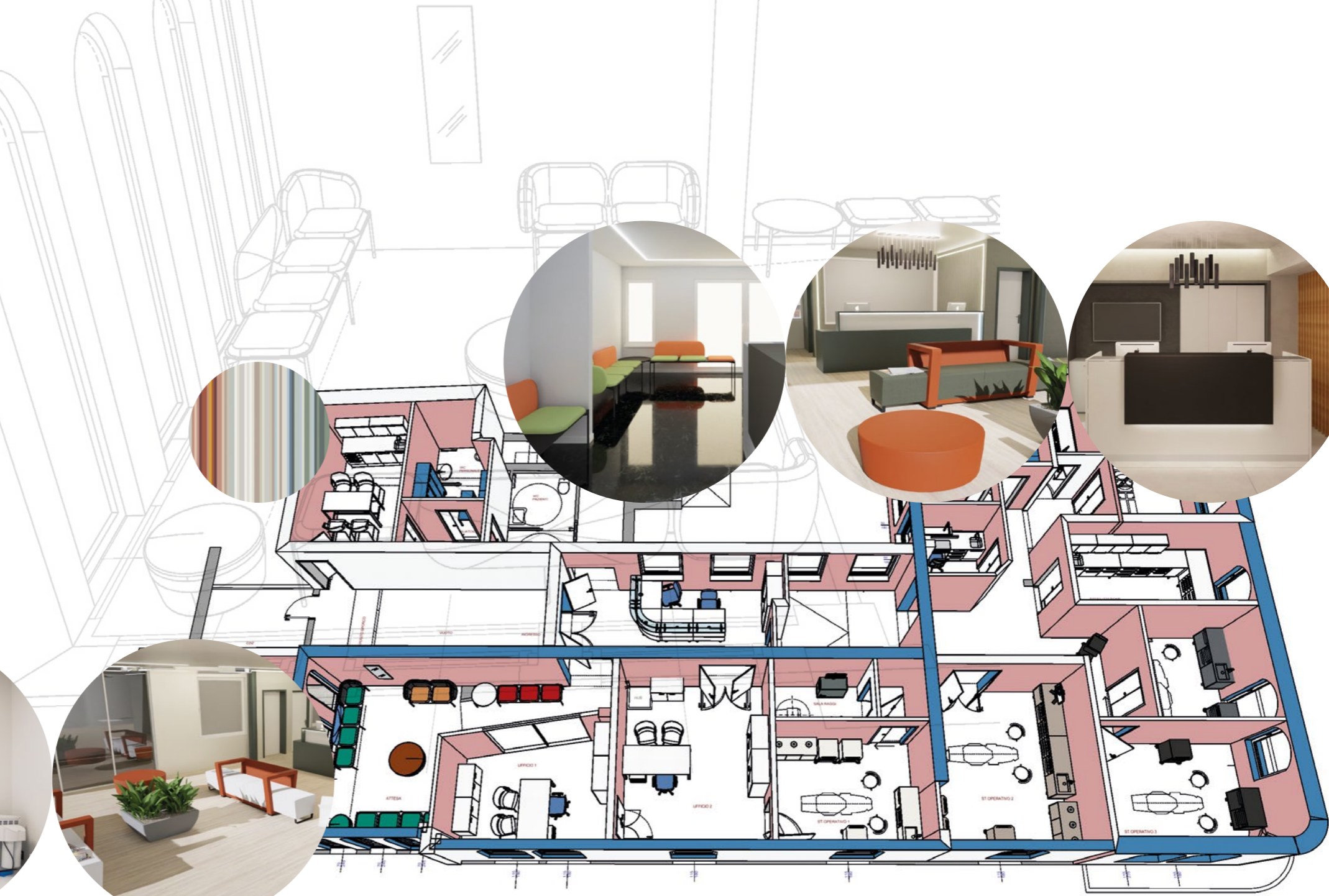

Progetto Ambiente

Per garantire standard di progetto elevati e realizzare arredi "sartoriali", utilizziamo tecnologie all'avanguardia curando ogni singolo aspetto: dagli studi preliminari alla progettazione esecutiva.

/ To ensure high design standards and make "tailor-made" furniture, we use state-of-the-art technology by taking care of every single aspect: from preliminary studies to executive design.

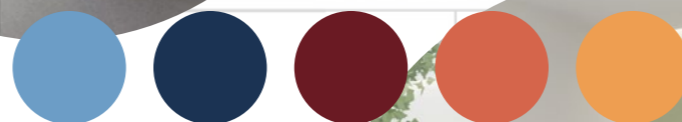
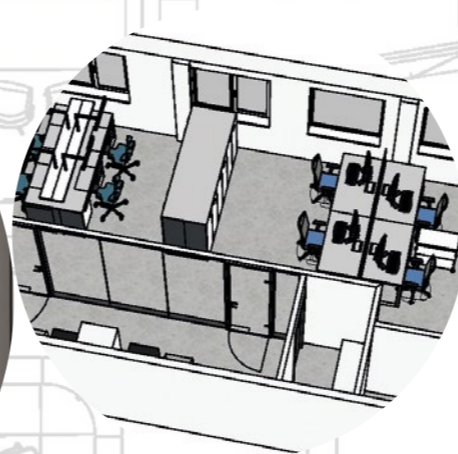

Idee, immagini e testi copyright Edarredo non riproducibili. Edarredo declina ogni responsabilità relativa ad eventuali inesattezze contenute in questo catalogo se dovute ad errori di stampa e/o di riproduzione grafica di disegni e fotografie e/o trascrizione e si riserva il diritto di apportare e/o far apportare senza preavviso le correzioni di inesattezze e/o errori di stampa e/o riproduzione. Edarredo si riserva il diritto inoltre di apportare, in qualsiasi momento e senza preavviso, tutte le modifiche tecniche, estetiche e funzionali ai prodotti che ritiene opportune per il miglioramento degli stessi. I colori e i materiali riprodotti nelle immagini stampate hanno un valore indicativo.

/ Ideas, images and text copyright Edarredo not reproducible.

Edarredo declines any responsibility regarding inaccuracies contained in this catalogue if due to printing and/or graphic reproduction errors in drawings and photographs and/or transcription and reserves the right to make and/or have made corrections of inaccuracies and/or printing and/or reproduction errors without notice. Edarredo reserves the right to make, at any time and without notice, all technical, aesthetic and functional changes to the products that it deems appropriate for their improvement. The colors and materials reproduced in the printed images are for illustrative purposes only.

© copyright November 2024

CONNECTING PEOPLE AND SPACES
@edarredo

edarredo.

edarredo.

Edarredo srl
e-mail: edarredo@edarredo.it
www.edarredo.it

